

DEM8.5/10

- Istruzioni per l'uso pag. 2
- Use and maintenance manual pag. 11
- Mode d'emploi et d'entretien pag. 20
- Betriebsanleitung pag. 29
- Gebruiksaanwijzing pag. 38
- Instrucciones de uso pag. 47
- Manual de instruções pag. 56
- Οδηγίες χρήσηςσελ. 65

Air always contains a certain amount of water in the form of vapour. This is commonly known as humidity. This determines the level of humidity in an atmosphere. The capacity of the air to hold water vapour increases with temperature. This is why in our homes, as soon as the temperature decreases, the vapour contained in the air condenses, as is evident on the colder surfaces in the room, such as the windows, walls etc.

The purpose of a dehumidifier is to remove the excess moisture from the air, avoiding the damage caused by condensation. Experts have established that the optimum environmental conditions for our well being and for the home are obtained between 40% and 60% relative humidity. Below these levels the air can feel too dry and may cause skin complaints and even static electric shocks

With temperatures lower than 5°C, you are recommended to heat the room even minimally. With heating, the condensation formed by the water vapour on windows and other cold surfaces evaporates into the air to be collected by the dehumidifier. Air leaving the dehumidifier is usually about 1°C warmer than room temperature.

IMPORTANT INFORMATION FOR CORRECT DISPOSAL OF THE PRODUCT IN ACCORDANCE WITH EC DIRECTIVE 2002/96/EC.



At the end of its working life, the product must not be disposed of as urban waste. It must be taken to a special local authority differentiated waste collection centre or to a dealer providing this service. Disposing of a household appliance separately avoids possible negative consequences for the environment and health deriving from inappropriate disposal and enables the constituent materials to be recovered to obtain significant savings in energy and resources. As a reminder of the need to dispose of household appliances separately, the product is marked with a crossed-out wheeled dustbin.

Description/Accessories

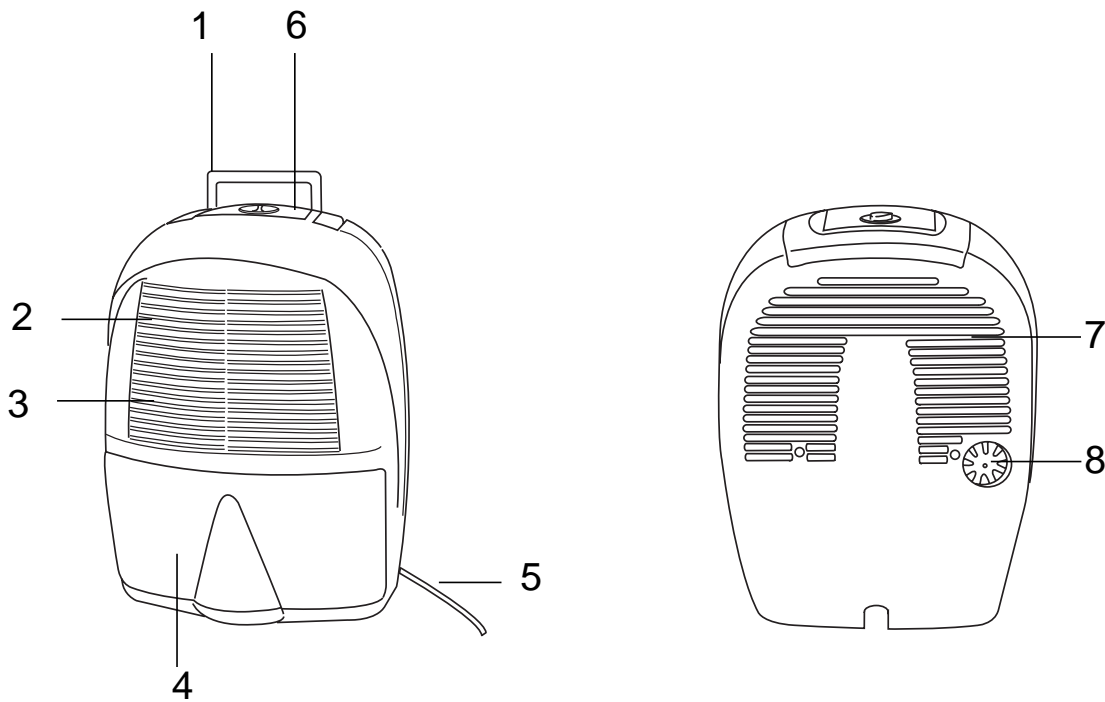

- | | |
|-------------------------------|-------------------------|
| 1. Lifting handle | 5. Power cable |
| 2. Dust filter (internal) | 6. Control panel |
| 3. Air intake grille | 7. Air outlet grille |
| 4. Condensate collection tank | 8. Continuous drain cap |

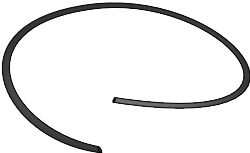
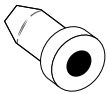
Accessories	Description
	condensate drain hose
	rubber bung

Important safeguards

- Use this appliance only as described in this instruction manual. As with all electrical equipment, whilst the instructions aim to cover as many eventualities as possible, Caution and common sense should be applied when operating and installing this appliance.
- This appliance is designed to dehumidify domestic rooms and must not be used for other purposes.
- It is dangerous to modify or alter the characteristics of the appliance in any way.
- If the appliance requires repair, always contact a Service Centre authorised by the manufacturer. Always insist on original spare parts. Repairs carried out by unauthorised personnel may be dangerous and invalidate the guarantee.
- This appliance must be used exclusively by adults. Do not allow children to play with the appliance.
- The appliance must be installed in conformity with legislation in force in the country concerned.
- If the power cable is damaged, it must be replaced by specialist personnel only.
- The appliance must be connected to an efficient earth installation. Have your electrical circuit checked by a qualified electrician.
- The use of extension leads is not recommended, however if it is necessary then follow carefully the extension leads instructions, and most importantly ensure that the extension lead is correctly rated in accordance with the appliance being used and never overloaded.
- Before cleaning or maintenance, always unplug the appliance from the mains socket.
- Do not move the appliance by pulling the power cable.
- Do not install the appliance in rooms containing gas, oil or sulphur. Do not install near sources of heat.
- Do not use the appliance on sloping surfaces.
- Keep the appliance at least 50 cm away from flammable substances (alcohol etc) or pressurised containers (e.g. aerosol cans).
- Do not rest heavy or hot objects on top of the appliance.
- Clean the air filter regularly.
- Always transport the appliance upright or resting on one side. Remember to drain the condensate tank before moving the appliance. Wait at least 1 hour after transporting the appliance before starting it.
- R134a refrigerant complies with EEC environmental standards. However, you should avoid perforating the refrigerant circuit. At the end of its working life, consign the appliance to a specialist collection centre.
- The materials used for packaging can be recycled. You are therefore recommended to dispose of them in special differentiated waste collection containers.
- Do not use the appliance outdoors.
- Do not obstruct the air intake or outlet.

Assistance

Keep the list of Service Centres and identify the Centre nearest you.

Electrical connections

Before using for the first time, the dehumidifier should be stood upright for 24 hours.

Failure to respect this safety rule absolves the manufacturer from all liability. This appliance is manufactured in compliance with ECC standard EN55014 on the suppression of radio interference.

The cable must be replaced by approved service personnel only.

After moving the appliance, wait at least an hour before turning it on again.

Before plugging the appliance into the mains socket, check that:

- The mains power supply corresponds to the power supply indicated on the rating plate.
- The power socket and electrical circuit are adequate for the appliance.
- The power socket matches the plug. If this is not the case, have the plug replaced by a qualified electrician;
- The power socket is adequately earthed.

Installation

Position the appliance in the room to be dehumidified:
A free space of at least 50 cm must be left at the front and back of the dehumidifier, so as not to block the air intake or outlet.

Do not place the dehumidifier next to a radiator or other heat source as this will reduce its performance.

For ongoing usage we suggest positioning in a hallway or on a landing. Please remember to keep internal door ajar to allow circulation.

The water collected (condensate) can be drained in one of the two ways:

A) Draining into the tank

The condensate can be drained directly into the tank (fig.1).

The tank can be easily removed (fig.1).

fig. 1

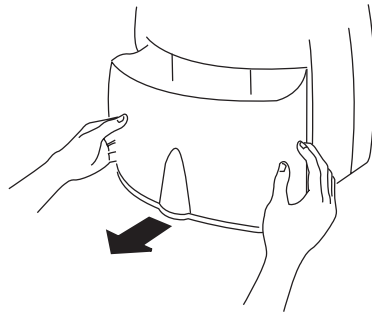

B) Continuous external draining

If the appliance is to be operated for long periods but you are unable to empty the tank regularly, you are recommended to use the continuous drain facility.

- 1) Remove the continuous drain cap (8) and the rubber bung (see figure 2).
- 2) Fasten the rubber hose to the spout. For models supplied without drain hose, we suggest you purchase a rubber hose around 2m long, with an internal diameter of 13.5 mm.
- 3) Make sure the end of the hose is no higher than the spout or water could remain in the tank. Check there are no kinks in the hose (Fig. 3).

N.B.: Keep the rubber bung. You will need it to plug the hose or close the spout if you revert to draining into the tank. (see point A)

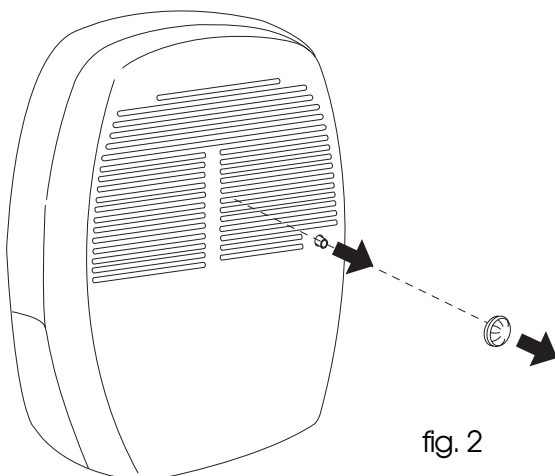

fig. 2

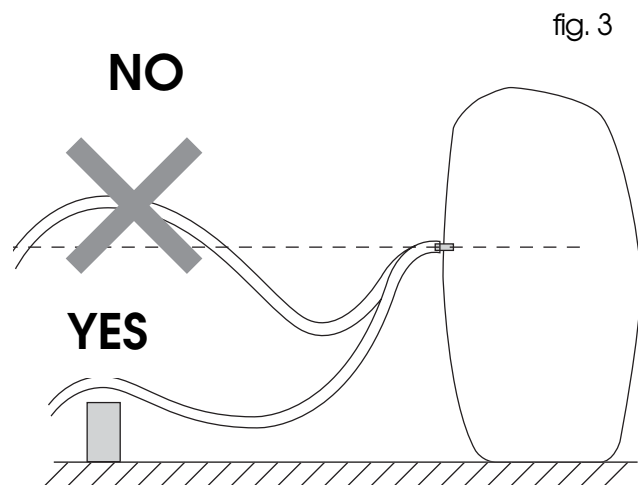
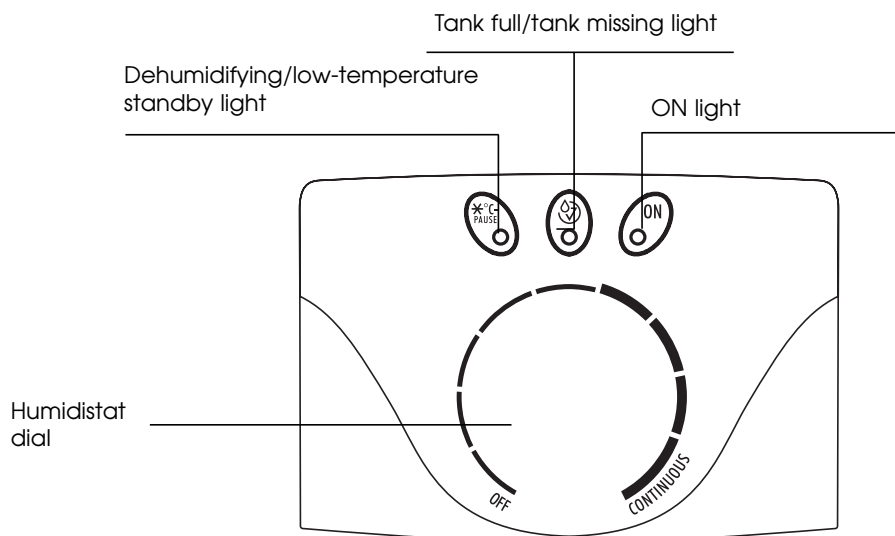

fig. 3

How to dehumidify

- 1) Plug the appliance into a mains socket.
- 2) Make sure the "tank full/tank missing" light is off. If it is on, position the tank correctly or empty it.
- 3) Turn the humidistat dial to one of the positions between **OFF** and **CONTINUOUS**. The **ON** light indicates that the appliance is dehumidifying. With the humidistat turned to "**CONTINUOUS**", the appliance is on all the time.



To easily select the right humidity level, we suggest you operate as follows:

Turn the humidistat dial clockwise as far as it will go to the continuous position.

Leave the unit on this setting until signs of excess moisture (e.g. condensation on windows) decreases. This can take several weeks at this point slowly turn the humidistat knob anti-clockwise until the appliance switches off. The dehumidifier will then keep the humidity at the selected level automatically.

Indicator lights



Tank control system light

This dehumidifier has a special device to ensure correct operation.

A light on the control panel comes on to warn the user when:

1. the tank is full *empty the tank*
2. the tank is missing *reposition the tank*
3. the tank is incorrectly positioned *position the tank correctly*
4. with continuous drain: the hose is obstructed
or placed too high above the drain spout *remove the obstruction*

When the cause has been removed, the light goes off and the appliance resumes operation.

ON Dehumidifying light

This comes on when the appliance is dehumidifying. The light stays on only while the appliance is actually dehumidifying. If the humidity in the room is sufficiently low, the light remains off.



Dehumidifying standby/low-temperature operation light

The light comes on to indicate low temperature operation.

When the room temperature is too low, the electronic low temperature operation device is activated. This device allows the appliance to operate by alternating dehumidification cycles and fan only cycles. This is to avoid the formation of ice. For frequent use in cold environments, it is recommended to heat the room at the same time.

This allows the dehumidifier to operate in conditions that ensure better performance and faster dehumidification.

Maintenance

Always unplug the appliance from the power socket before performing any cleaning or maintenance operations.

For safety reasons, never wash the dehumidifier using a jet of water.

Cleaning the cabinet

- Clean the appliance using a damp cloth then dry with a dry cloth.
- Never use petrol, alcohol or solvents to clean the appliance.
- Never spray liquid insecticide or similar products as they may deform the plastic.

Cleaning the air filter

If the filter is dirty, air circulation is compromised and the efficiency of the dehumidifying and air purifying functions decreases.

It is therefore good practice to clean the filter at regular intervals. The frequency depends on the duration and conditions of operation. If the unit is used constantly or systematically, you are recommended to clean the filter once a week.

- To remove the air filter, take out the tank and extract the filter by pulling downwards (fig. 4).
- Use a vacuum cleaner to remove dust accumulations from the filter. If the filter is very dirty, wash in warm water and rinse several times.
- The temperature of the water must not exceed 40°C.
- After washing the filter, allow it to dry completely before repositioning it.

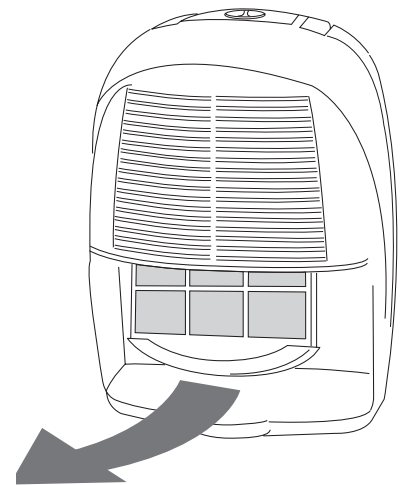

fig. 4

If the appliance is not used for long periods

- After having unplugged the appliance from the power socket, empty the tank.
- Clean and reposition the filter.
- Cover the appliance with a plastic bag so that dust does not build up.

Troubleshooting

Check the following points before calling your local authorised Service Centre.

Problem	Cause	Solution
The appliance does not work in dehumidifying mode (indicator light off)	<ul style="list-style-type: none">•the appliance is not plugged in•no electricity•the humidistat is on minimum•the tank is full of water•the tank is incorrectly positioned	<ul style="list-style-type: none">•plug into the mains•check the power supply•turn the humidistat to the max position•empty the tank•position the tank correctly
The appliance is operating in dehumidifying mode (light on), but the humidity does not decrease	<ul style="list-style-type: none">•the filter is blocked•the temperature or humidity in the room is too low •the room is too large•too many sources of humidity in the room (pots of boiling water, etc.)	<ul style="list-style-type: none">•clean the filter•in certain conditions, it is normal for the appliance not to dehumidify (in these cases the room being dehumidified should also be heated)
The appliance does not work for around 3 minutes when restarted	<ul style="list-style-type: none">•The safety device has tripped	<ul style="list-style-type: none">•wait for 3 minutes to pass

Technical specifications

Power supply voltage
Absorbed power
Maximum power input
Absorbed current
Frost protection device
Humidistat
Fan speeds
Air filter
Dimensions HxWxD
Tank capacity
Operating limits:
• temperature
• relative humidity

DEM8.5/DEM10	
	See rating plate
	"
	"
	"
	yes
	yes
	1
	yes
	415x330x260mm
	2 litres
	Dehumidifying
	2° - 30
	30 - 95%

ENGLISH