



- Repair of the appliance due to the effects of a lack of cleaning such as dirt, mould, grease, spillages and odours or due to the effects of limescale.
- Any blockages to pump or filter in washing machines and dish washers.
- Punctured evaporators and lack of cleaning (e.g.. blocked gas jets)
- Any parts which are fitted to the product which are not original manufacturer's parts
- Operation at incorrect voltage.
- No Fault Found.
- Scratches and chips to ceramic hob glass surface resulting in the use of inappropriate cooking utensils.
- Noise, vibration or steam resulting in the operation of the appliance. This includes steam from washer, dryer, dishwasher and ovens, running of oven fans, drain pumps.
- Being used in a non-domestic environment, second hand, or those used by several people in communal areas. A service charge could be made if a fault is not a mechanical or electrical manufacturing fault.

Disclaimer

- The manufacturer will not be held responsible for any damages resulting from inappropriate usage of the appliance.
- The Guarantee is valid in the United Kingdom and the Republic of Ireland only.
- The Guarantee is non-transferable and only relates to the original purchaser of this appliance.
- Where deemed necessary by Haden for an appliance to be exchanged within the guarantee period, the new appliance will be covered by the original guarantee period and will not be subject to a new guarantee.
- Haden reserve the right to inspect the appliance before exchange/replacement can take place.
- Haden disclaims any liability for consequential loss or damage.
- This Guarantee does not in any way diminish your statutory or legal rights.

Manufacturer

HADEN
Sabichi Homewares Limited
Sabichi House
5 Wandsworth Road,
Perivale,
Middlesex
UB6 7JD

Service Hotline: 01759 487830
Email: admin@hadenwarranty.co.uk

To request a service call Tel. 01759 487830



HADEN

User's Manual

Built-in Electrical Oven

**HSBI05W - X
HSBI08W - X**

To request a service call Tel. 01759 487830



CONTENTS

General warranty conditions
Installation
Operation
Maintenance and cleaning
Technical specifications

Attention

- Read carefully the user's manual before use and installation of the appliance.
- Keep the user's manual for future use.
- This appliance is not designed for industrial or laboratory use. Use this appliance only for its intended use.

THESE INSTRUCTIONS MUST BE FOLLOWED:

Remove all internal and external packing materials from the appliance and check for transportation damage.

In case of damage, do not operate the appliance and contact your authorised service provider.

Keep children away from all packaging, which may cause danger.

Prior to installation, ensure that the main voltage conditions and the adjustment of the appliance are compatible.

This appliance must not be used to heat a room.

This appliance must be installed and connected in accordance with current installation regulations.

Particular attention should be given to the relevant requirements regarding ventilation.

The use of cooking appliances results in the production of heat and moisture in the room in which it is installed. Ensure that the kitchen is well ventilated: keep natural ventilation holes open or install a mechanical ventilation device (mechanical extractor hood). Prolonged intensive use of the appliance may call for additional ventilation, for example opening of a window, or increasing the level of mechanical ventilation where present.

To request a service call Tel. 01759 487830

Product Guarantee information:

Your Haden product is covered by Guarantee for 24 months from the date of the original purchase. Please ensure you register your product and keep your receipt (proof of purchase) and serial number in a safe place.

You can register your Haden product **by calling 01759 487830**

What is covered?

- Electrical and mechanical faults deriving from faulty materials defective components or a manufacturing defect.
 - Replacement functional parts.
 - Labour costs of an approved Haden engineer.
- Your Haden Guarantee covers domestic use at residential addresses and is subject to the following conditions.

Guarantee exclusions:

- Transit / delivery damage or cold weather damage.
- Incorrect installation:

Please ensure that your Haden appliance has been correctly and safely connected to mains supplied electricity, gas and water and drainage as appropriate and in accordance with the instruction manual. Gas appliances must be properly installed by a qualified Gas Safe (or BORD GAIS) installer. LPG conversions will be covered only if a copy of the necessary certification is provided at the time of registration by a qualified Gas Safe (or BORD GAIS) installer. We recommend that all electric cooking products, washing machines and dishwashers are installed by a qualified plumber / electrical appliance installer.

- Repair of, or interference with, the product by any person not authorised by the manufacturer to carry out service.
- Improper use or abuse.
- Accidental damage.
- Reversal of door or door handles on cooling appliances.
- Repair or replacement of any cosmetic or consumable parts such as bulbs, plugs, fuses, cables, filters and attachments, control knobs, flaps, container lids, handles, glass and wire shelves, rubber hoses, plastic door shelves and any accessories for example Oven baking trays and shelves. These include any parts which have become worn, discoloured or damaged, including damage by incorrect use or cleaning.

To request a service call Tel. 01759 487830

GENERAL WARRANTY CONDITIONS:

This appliance is under warranty covering only the replacement of the defective parts and free of charge repair during the period of the warranty. Please keep your receipt to present to our Authorised Service Provider before a repair can be booked.

The connection and installation of the appliance can only be carried out by authorised service personnel.

This appliance must be grounded.

Problems arising due to improper installation are not covered by the warranty. Unauthorised repair or modification of the appliance invalidates the warranty.

Information concerning disposal

Disposal of packaging

The packaging protects your appliance from damage during transit. All utilised materials are environmentally safe and recyclable. Please help us by disposing of the packaging in an environmentally friendly manner. Please ask your dealer or enquire at your local authority about current means of disposal.

Disposal of your old appliance

Old appliances are not worthless rubbish! Valuable raw materials can be reclaimed by recycling old appliances.

This appliance is identified according to the European guideline 2012/19/EU on waste electrical and electronic equipment-WEEE. The directive specifies the framework for an EU-wide valid return and re-use of old appliances. Compliant with WEEE Regulations.



To request a service call Tel. 01759 487830

This appliance is not intended for use by people (including children) with reduced physical, sensory or mental capabilities, or lack of experience and knowledge, unless it is under supervision or having been given instructions concerning the use of the appliance by a person responsible for their safety.

Children should be supervised to ensure that they do not play with the appliance.

In the case that the power cable must be replaced, the replacement must be made **ONLY** by, an authorised service person.

Installation work must be performed in accordance with national wiring standards, by authorised service personnel **ONLY**.

INSTALLATION

- This appliance must be installed in full accordance with national standards and regulations, please refer to national and local instructions.
- This appliance must be installed in a cabinet designed for an oven
- Install the appliance in a position where the oven door can be opened freely.
- Install the appliance away from inflammable materials.
- Make sure that the main voltage matches the details on the rating plate.
- Before connecting this appliance ensure that all knobs are set to the “O” position.
- Ensure that, there is nothing inside the oven then, leave the oven door open and set the thermostat to the “maximum” temperature level and oven selector knob to the “upper/lower” position for 10 minutes.
- Switch off the oven and leave it to cool down.
- The same procedure is required for the Grill leaving the door open.
- Set the knob to the “Grill” position and operate for 10 minutes.
- Switch off the grill and leave it to cool down.

When you use the appliance for the first time a temporary smell and form of smoke will occur, this is due to the protective grease on the heating elements, This is normal.

Following the first use of the appliance, the smell will go away as the elements will be free from the protective grease layer.

During this operation, ensure that the room is well ventilated.

- Once you are sure that your oven is totally cooled down, clean the oven by wiping it with a damp cloth or sponge.

To request a service call Tel. 01759 487830

INSTALLING INTO THE KITCHEN CABINET

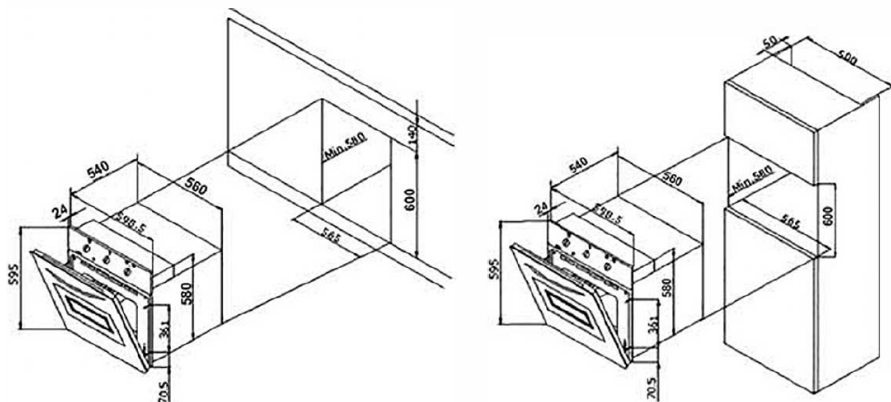

INTRODUCTION

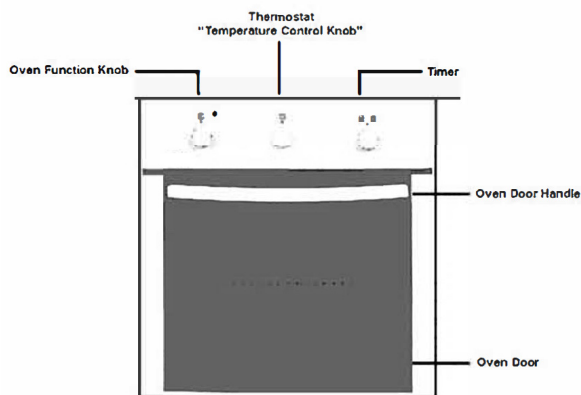

CONTROL PANEL

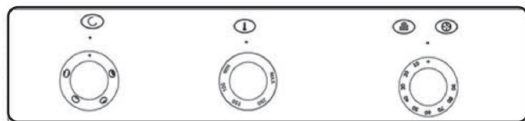

To request a service call Tel. 01759 487830

TECHNICAL SPECIFICATIONS

TECHNICAL FEATURES	HSBI05W - X HSBI08W - X
Type per model	Multifunction oven with Mechanical Timer
Dimensions (net)	595x599x570
Voltage	220-240 V AC
Total power	2077 W
Upper heater	1000 W
Lower heater	1000 W
Grill	2000 W
Turbo heater	
Oven lamp	15 W
Thermostat	50-185 C
Oven Capacity	65
Net weight	Kg. 32.550
Timer mechanical	0-90 minutes
Defrost feature	Yes
Cooling fan	Yes

Regulation (EU) 65/2014

Brand		HADEN
Model		HSBI05W - X HSBI08W - X
Construction		Built-in Oven
Number of cavities	Nbr.	1
Energy efficiency index cavity I	EEI	103
Energy efficiency class cavity I		A
Energy consumption conventional heating, cavity I	kWh/cycle	0.86
Energy consumption fan forced heating, cavity I	kWh/cycle	0.83
Heat source cavity I		Electric
Volume cavity I		61
Energy efficiency index cavity II	EEI	
Energy efficiency class cavity II		
Energy consumption conventional heating, cavity II	kWh/cycle	
Energy consumption fan forced heating, cavity II	kWh/cycle	
Heat source cavity II		
Volume cavity II		

To request a service call Tel. 01759 487830

Maintenance and cleaning

- Disconnect the appliance from the mains power before maintenance and cleaning.
- Please wait until the appliance completely cools down.
- The appliance must only be cleaned with a damp cloth or sponge.
- Never use abrasive powder.
- Do not use harsh abrasive cleaners or sharp metal scrapers to clean the oven door glass, as they can scratch the surface, which may result in shattering of the glass.
- Steam cleaners must not be used for cleaning or any other purposes.
- The enamelled parts can be cleaned with soapy water and a soft clean cloth.
- In order to prevent damage do not scrape dirt off the control panel with sharp tools that may scratch and cause damage.

CAUTION:

ENSURE THAT THE APPLIANCE IS DISCONNECTED FROM THE POWER SUPPLY (SWITCHED OFF), BEFORE CLEANING OR REPLACING THE OVEN LAMP, TO AVOID THE POSSIBILITY OF ELECTRIC SHOCK.

The oven door is also removable for easy cleaning.

First open the oven door completely, flip up the hinge catch on the hook of both sides of the door. Grasp the door with both hands, raise a little and pull it backwards.

Following cleaning or maintenance, do not forget to re-do the hinge catches after placing the oven door back to its housing.

To extend the economical life of your appliance, take regular care and always keep the oven door open until the oven gets completely dry.

Any spillage should be removed from the lid before opening and hob surface and should be allowed to cool before closing the lid.

Particularly, pay attention not to pour water on the appliance during operation, and always avoid contact with acid or alkaline containing substances, such as vinegar, lemon, juice, salt etc. if this occurs, wipe and clean immediately paying attention to the hot parts of the appliance

ATTENTION

- **Do not place your cooking utensils (baking tin, baking pan, drip tray etc.) or aluminum foil at the bottom of the oven. This can cause damage to the enamel surface of the oven due to high temperature.**
- **During use the appliance becomes hot. Care should be taken to avoid touching the heating elements inside the oven.**
- **Warning: Accessible parts may become hot during use. Young children should be kept away, your oven can be used as a grill with the door open.**
- **Cleaning: The oven must be switched off before removing the guard, after cleaning the guard must be replaced in accordance with the instructions.**
- **Lamp for illumination: Warning ensure that the appliance is switched off before replacing and/or cleaning the lamp to avoid the possibility of electric shock.**
- **This appliance must be installed in accordance with british standards.**

OPERATION

Oven

The oven heat is adjustable between min. and max. by means of the thermostat control knob.

The signal lamp will indicate the operation of the heaters. Upon reaching the desired temperature level, the signal lamp will turn off. The thermostat will maintain the temperature level inside the oven, during the cooking process.

Before cooking, it is advised to pre-heat the oven for five minutes.

The inner lamp of the oven comes on when the oven control knob is used to select a function.

CAUTION:

Upper and lower Heater

This function is for cooking both with the upper and lower heater at the same time.

Lower Heater with Fan

This function, applies more heat to the base of your dish, you may also use this function to warm your plates.

Grill

When the grill function is used, open the door of the oven and attach the heat deflection panel (supplied with the oven) to the door of the oven.

This way, you will avoid possible damage to the control panel and also prevent overheating of the control knobs. Hence, the door of the oven will stay slightly open during grilling process.

By choosing the Grill position, the double power heater will operate.

You will receive that charcoal cooked taste, while grilling meat, chicken or fish.

It is advised to pre-heat the Grill for 5 to 10 minutes.

To prevent sticking, place the meat, chicken or fish on an oiled grid and place it on the upper shelf of the oven, while placing another tray on the lower shelf of the oven to collect any dripping fats or oil.

Defrost

Place the frozen food on the middle of the grid on the third shelf of the oven, to ensure air circulation. Another tray should be placed on the lower shelf, to collect dripping water. Close the lid and select the defrost position.

Classical Cooking with Turbo

With this function, the turbo fan works with the lower and upper heaters of your oven.

This is advised for cakes and cookies with short baking times and produces a consistent temperature throughout the oven. Always pre-heat the oven in this mode.

To request a service call Tel. 01759 487830

USING THE MECHANICAL TIMER

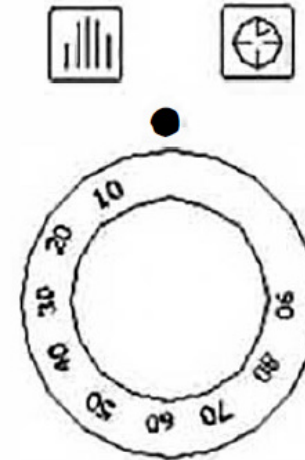

Turn the time, knob, clock-wise.

Set the desired minutes.

Select the correct temperature and function for cooking.

The oven will start operating.

The timer will count down the minutes then the oven will be turned off automatically, when the timer knob comes to the (•) position.

The oven will not operate unless the timer knob is at (•) position.

By choosing the 'M' manual step; the oven will operate as long as the timer knob is at 'M' position.

To stop the cooking process, the thermostat knob should be set back to (•) position. Do not forget to set the timer knob from 'M' back to (•) position, otherwise your oven will keep operating.

To request a service call Tel. 01759 487830

CHILD LOCK

When activated after a cooking program is entered, the buttons get locked, ie. pressing the button! will have no effect. This is to prevent your child interrupting or disturbing a cooking program which is in progress.

When activated when no cooking program is in progress, again the buttons are locked but in addition, the oven is inoperative. This is to prevent your child from activating the oven accidentally.

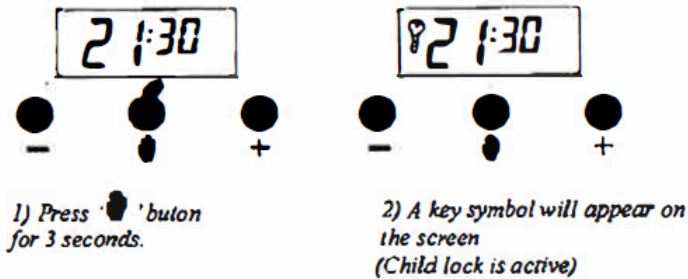

To cancel child lock mode, repeat this process.

Note: The buzzer sound can be stopped by pressing and releasing the - button without cancelling the function itself

CLOCK MODE 12/24 HOUR

You may select 12h or 24h (AM/PM) time of day display.

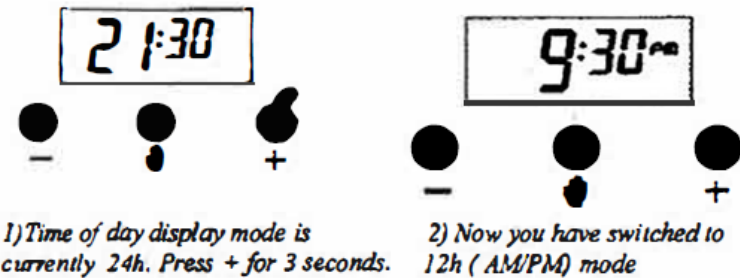

Pressing + button for 3 seconds again. will toggle the mode.

Note: The factory setting is 24h mode. Long power offs results in this mode ..

BUZZER TONE ADJUSTMENT

You may adjust the buzzer tone of the timer in the following way:

- 1) Pressing the (-) button, you can hear the currently set tone.
- 2) Releasing (-) and then pressing again, you can hear the next available (total 3) tone.
- 3) The last sound heard will be your selected one.

Note: the factory setting is the maximum level (highest frequency) A long interruption of power may result in reloading this setting.

To request a service call Tel. 01759 487830

USING THE DIGITAL TIMER

Overview

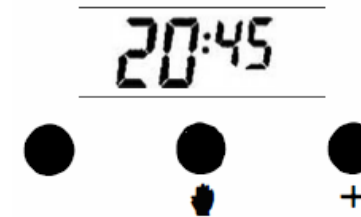

This electronic timer, enables you to have food ready to serve at a desired time. This is done by programming the cooking time and the ready time.

It can also be used as an alarm clock, where you program the time after which the buzzer will sound.

POWER UP:

On power up, the clock will show (0:00) and auto will be flashing on the screen. The timer cannot be programmed until the clock is set.

To do this you must enter manual mode.

MANUAL MODE

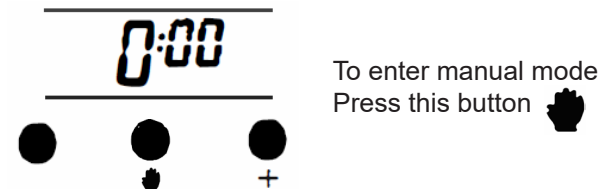

TIME OF DAY ADJUSTMENT

You can only adjust the displayed time, if no automatic cooking program is in progress. Enter manual mode (explained before). Press and release the key symbol button until the double points between the hours and minutes flash. Using the + and - buttons, you can adjust the time of day. Long presses of these buttons will enable fast adjustment.



Note: On power on the first press of key symbol brings you into time of day adjustment mode

To request a service call Tel. 01759 487830

ADJUSTING THE BUZZER ALARM

With this feature, you can program how much time should elapse before the buzzer sounds

1) Press once the button Bell symbol starts to flash

2) Give in the period of time to be counted down using + or - buttons

3) After a few seconds, the screen will return displaying the current time of day

CANCELLING THE BUZZER ALARM

1) Buzzer will sound after the programmed amount of time.

2) Press the - button to cancel the sound.

AUTOMATIC COOKING PROGRAM

If you want to start cooking immediately, you just have to give in the cooking time.

Example: We placed our food into the oven and want it to be cooked for 2 hours 15 minutes.

1) Current time is 18:30

2) Pressing twice enter cooking duration menu Chicken symbol flashes

3) Adjust the cooking time using the + and - buttons.

Now, you have programmed your oven to cook the food for 2 hours and 15 minutes. Please do not forget to set the function and/or the temperature knobs of your oven to appropriate positions.

After a few seconds, the screen will indicate that cooking has started and show the current time of day.

Note: You may cancel automatic cooking at any time by setting the cooking duration to zero.

To request a service call Tel. 01759 487830

SETTING THE FOOD READY TIME

In the previous example, cooking started immediately after entering the cooking period. By pressing 3 times, you will see the cooking end time (when the food will be ready) and also adjust this time. In the example below, the ready time will be shifted to 21:30.

1) Press button 3 times. On the screen the cooking end time is indicated as 18:30+2:15=20:45.

2) Set it to the desired time by using + or - buttons

3) In a few seconds, screen switches to clock mode.

We now have programmed our oven to have the food ready at 21:30. Since the cooking time was preprogrammed as 2 hours and 15 minutes, your oven will start cooking at 19:15, so the food is ready at 21:30.

When automatic cooking is completed, the buzzer alarm will sound, for 7 minutes or until stopped.

1) Switch OFF the oven

2) Reset the timer.

Note: Your oven will be inoperative until you reset the timer.

In the example shown, cooking time was programmed first, the ready time was calculated automatically. It is also possible to program the ready time first. In this case, the cooking time will be calculated automatically.

IN CASE OF MAINS POWER LOSS

Mains power losses excluding short time periods, will bring your oven into OFF mode. The clock will appear as a flashing 0:00 together with the 'A' symbol. Any cooking program in progress will also be cancelled. Enter the manual mode and adjust the clock using + or - buttons.

Note: if you do not intend to use your oven right now, make sure that the control knob is in OFF position.

To request a service call Tel. 01759 487830